

LONGITUDINAL PROFILE

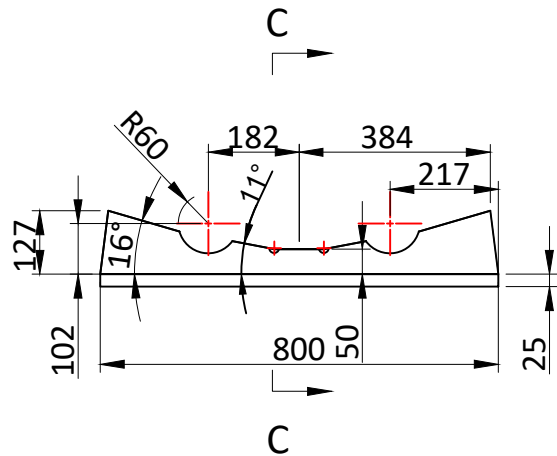

TRANSVERSAL SECTION "A"

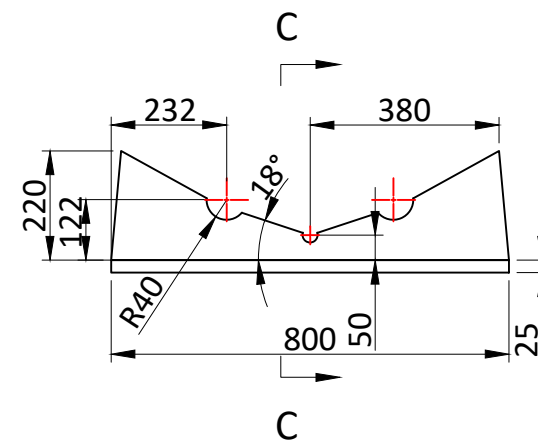

TRANSVERSAL SECTION "B"

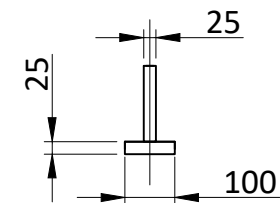

TRANSVERSAL SECTION "C"



UL240 CHOCK

DWN: QCJ

APPROVED: XQC

info@highfieldboats.com

DWG:

SCALE:

DATE: 2024.12.20

(C) Copyright reserved. No unauthorized use allowed.  
All intellect - ideas - concepts remain the property of Highfield Boats